

Type number key

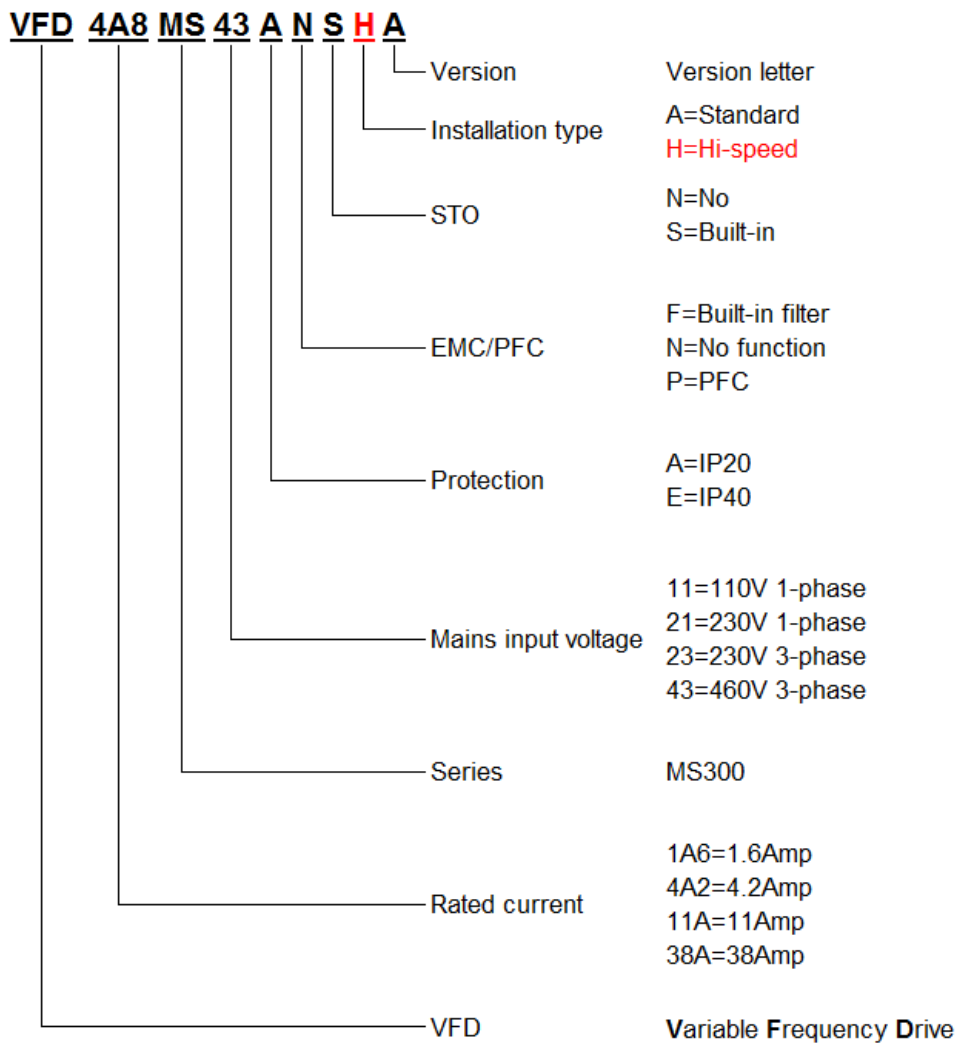

230V 1phase 1.5 ~ 2.2kW with built-in filter

Type number	VFD□□□MS21AFSHA	7A5	11A
Rated power	kW	1.5	2.2
Rated output current (HD)	A RMS	7.5	11
Overload (HD)	%	150% 60s 200% 3s	
Rated output capacity (HD)	kVA	2.9	4.2
Rated input current (HD)	A RMS	15.8	23.1
Mains fuse (for UL: Bussmann)		JJS-35	JJS-50
Non-fuse current breaker	A	45	70
Dimensions HxWxD	mm	157x87x179	
Frame *		C2	
Weight	kg	1.8	
Protection **		IP20	
Power cable entry (with conduit box)	Ømm	2x 27.8	
Signal cable entry (with conduit box)	Ømm	2x 22.5	
Section of power cables, stranded (with ring)	mm ²	5.3~8.4	8.4
Cooling		Fan	
Cooling air flow rate	m ³ /hr	27.2	
Carrier frequency (HD)	kHz	2~15	
EMC-Filter		Built-in: C3 30m, C2 20m	
DC-Choke		Connection for option	
DC-Bus connection		Yes	
Brake chopper		Built-in	
Recommended brake resistor	Ω/W	91/200	70/300
Minimum brake resistor value	Ω	47.5	38

230V 1phase 0.2 ~ 2.2kW no filter

Type number	VFD□□□MS21ANSHA VFD□□□MS21ENSHA	7A5	11A
Rated power	kW	1.5	2.2
Rated output current (HD)	A RMS	7.5	11
Overload (HD)	%	150% 60s 200% 3s	
Rated output capacity (HD)	kVA	2.9	4.2
Rated input current (HD)	A RMS	15.8	23.1
Mains fuse (for UL: Bussmann)		JJS-35	JJS-50
Non-fuse current breaker	A	45	70
Dimensions HxWxD	mm	157x87x152	
Frame *		C1	
Weight	kg	1.24	
Protection **		A: IP20 E: IP40	
Power cable entry (with conduit box)	Ømm	2x 27.8	
Signal cable entry (with conduit box)	Ømm	2x 22.5	
Section of power cables, stranded (with ring)	mm ²	5.3~8.4	8.4
Cooling		Fan	
Cooling air flow rate	m ³ /hr	27.2	
Carrier frequency (HD)	kHz	2~15	
EMC-Filter		External option	
DC-Choke		Connection for option	
DC-Bus connection		Yes	
Brake chopper		Built-in	
Recommended brake resistor	Ω/W	91/200	70/300
Minimum brake resistor value	Ω	47.5	38

* See dimensional drawing on Page 5~6.

** See User Manual

400V 1.5 ~ 3.7kW with built-in filter

Type number	VFD□□□MS43AFSHA	4A2	5A5	9A0
Rated power	kW	1.5	2.2	3.7
Rated output current (HD)	A RMS	4.2	5.5	9
Overload (HD)	%	150% 60s 200% 3s		
Rated output capacity (HD)	kVA	3.2	4.2	6.9
Rated input current (HD)	A RMS	5.8	6.1	9.9
Mains fuse (for UL: Bussmann)		JJS20	JJS-25	JJS-45
Non-fuse current breaker	A	15	20	30
Dimensions HxWxD	mm	142x72x159	157x87x179	
Frame *		B3	C2	
Weight	kg	1.32	1.8	
Protection **		IP20		
Power cable entry (with conduit box)	Ømm	2x 22.5	2x 27.8	
Signal cable entry (with conduit box)	Ømm	2x 22.5		
Section of power cables, stranded (with ring)	mm ²	2.1~3.3	2.1~8.4	
Cooling		Fan		
Cooling air flow rate	m ³ /hr	16.99	27.2	
Carrier frequency (HD)	kHz	2~15		
EMC-Filter		Built-in: C3 30m, C2 20m		
DC-Choke		Connection for option		
DC-Bus connection		Yes		
Brake chopper		Built-in		
Recommended brake resistor	Ω/W	360/200	250/300	150/400
Minimum brake resistor value	Ω	126.7	108.6	84.4

400V 1.5 ~ 3.7kW no filter

Type number	VFD□□□MS43ANSHA VFD□□□MS43ENSHA	4A2	5A5	9A0
Rated power	kW	1.5	2.2	3.7
Rated output current (HD)	A RMS	4.2	5.5	9
Overload (HD)	%	150% 60s 200% 3s		
Rated output capacity (HD)	kVA	3.2	4.2	6.9
Rated input current (HD)	A RMS	5.8	6.1	9.9
Mains fuse (for UL: Bussmann)		JJS20	JJS-25	JJS-45
Non-fuse current breaker	A	15	20	30
Dimensions HxWxD	mm	142x72x143	157x87x152	
Frame *		B1	C1	
Weight	kg	1.05	1.24	
Protection **		A: IP20 E: IP40		
Power cable entry (with conduit box)	Ømm	2x 22.5	2x 27.8	
Signal cable entry (with conduit box)	Ømm	2x 22.5		
Section of power cables, stranded (with ring)	mm ²	2.1~3.3	2.1~8.4	
Cooling		Fan		
Cooling air flow rate	m ³ /hr	16.99	27.2	
Carrier frequency (HD)	kHz	2~15		
EMC-Filter		External option		
DC-Choke		Connection for option		
DC-Bus connection		Yes		
Brake chopper		Built-in		
Recommended brake resistor	Ω/W	360/200	250/300	150/400
Minimum brake resistor value	Ω	126.7	108.6	84.4

* See dimensional drawing on Page 5~6.

** See User Manual

400V 5.5 ~ 22kW with built-in filter

Type number	VFD□□□MS43AFSHA	13A	17A	25A	32A	38A	45A
Rated power	kW	5.5	7.5	11	15	18.5	22
Rated output current (HD)	A RMS	13	17	25	32	38	45
Overload (HD)	%	150% 60s 200% 3s					
Rated output capacity (HD)	kVA	9.9	13	19.1	24.4	29	34.3
Rated input current (HD)	A RMS	14.3	18.7	27.5	35.2	41.8	49.5
Mains fuse (for UL: Bussmann)		JJS-30	JJS-45	JJS-60	JJS-80	JJS-90	JJS-110
Non-fuse current breaker	A	32	45	60	80	90	100
Dimensions HxWxD	mm	207x109x187		250x130x219		300x175x244	
Frame *		D2		E2		F2	
Weight	kg	2.91		5.15		8.5	
Protection **		IP20					
Power cable entry (with conduit box)	Ømm	2x 34.5		2x 43.7		2x 50.1	
Signal cable entry (with conduit box)	Ømm	2x 22.5					
Section of power cables (stranded)	mm ²	5.3~8.4		8.4~13.3		13.3~33.6	21.2~33.6
Cooling		Fan					
Cooling air flow rate	m ³ /hr	39.7		91.2		115.2	
Carrier frequency (HD)	kHz	2~15					
EMC-Filter		Built-in: C3 30m, C2 20m					
DC-Choke		Connection for option					
DC-Bus connection		Yes					
Brake chopper		Built-in					
Recommended brake resistor	Ω/W	75/1000		43/1500	32/2000		26/3000
Minimum brake resistor value	Ω	50.7	40	33	26.2		23

400V 5.5 ~ 22kW no filter

Type number	VFD□□□MS43ANSHA VFD□□□MS43ENSHA	13A	17A	25A	32A	38A	45A
Rated power	kW	5.5	7.5	11	15	18.5	22
Rated output current (HD)	A RMS	13	17	25	32	38	45
Overload (HD)	%	150% 60s 200% 3s					
Rated output capacity (HD)	kVA	9.9	13	19.1	24.4	29	34.3
Rated input current (HD)	A RMS	14.3	18.7	27.5	35.2	41.8	49.5
Mains fuse (for UL: Bussmann)		JJS-35	JJS-45	JJS-60	JJS-80	JJS-90	JJS-110
Non-fuse current breaker	A	32	45	60	80	90	100
Dimensions HxWxD	mm	207x109x154		250x130x185		300x175x192	
Frame *		D1		E1		F1	
Weight	kg	2.07		3.97		6.25	
Protection **		A: IP20 E: IP40					
Power cable entry (with conduit box)	Ømm	2x 34.5		2x 43.7		2x 50.1	
Signal cable entry (with conduit box)	Ømm	2x 22.5					
Section of power cables (stranded)	mm ²	5.3~8.4		8.4~21.2		13.3~33.6	
Cooling		Fan					
Cooling air flow rate	m ³ /hr	39.7		91.2		115.2	
Carrier frequency (HD)	kHz	2~15					
EMC-Filter		External option					
DC-Choke		Connection for option					
DC-Bus connection		Yes					
Brake chopper		Built-in					
Recommended brake resistor	Ω/W	75/1000		43/1500	32/2000		26/3000
Minimum brake resistor value	Ω	50.7	40	33	26.2		23

* See dimensional drawing on Page 5~6.

** See User Manual

Frame sizes and dimensions in mm [inches]

Frame B

Frame	Unit : mm [inch]						
	W	H	D	W1	H1	D1	S1
B1	72.0 [2.83]	142.0 [5.59]	143.0 [5.63]	60.0 [2.36]	130.0 [5.63]	6.4 [0.25]	5.2 [0.20]
B2	72.0 [2.83]	142.0 [5.59]	143.0 [5.63]	60.0 [2.36]	130.0 [5.63]	3.0 [0.12]	5.2 [0.20]
B3	72.0 [2.83]	142.0 [5.59]	159.0 [6.26]	60.0 [2.36]	130.0 [5.63]	4.3 [0.17]	5.2 [0.20]

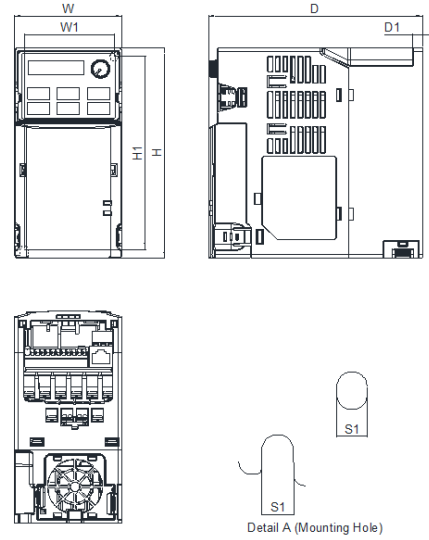

Frame C

Frame	Unit : mm [inch]						
	W	H	D	W1	H1	D1	S1
C1	87.0 [3.43]	157.0 [6.18]	152.0 [5.98]	73.0 [2.87]	144.5 [5.69]	5.0 [0.20]	5.5 [0.22]
C2	87.0 [3.43]	157.0 [6.18]	179.0 [7.05]	73.0 [2.87]	144.5 [5.69]	5.0 [0.20]	5.5 [0.22]

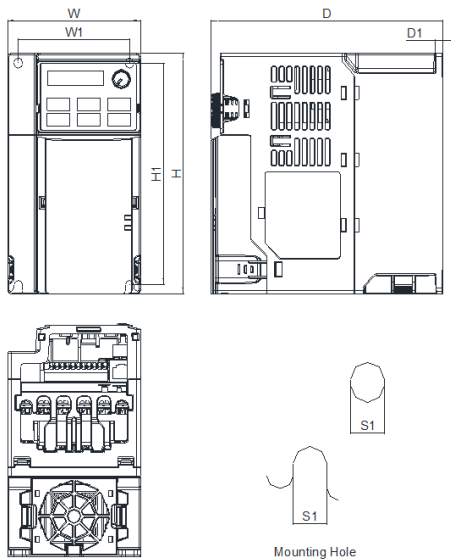

Frame D

Frame	Unit : mm [inch]						
	W	H	D	W1	H1	D1	S1
D1	109.0 [4.29]	207.0 [8.15]	154.0 [6.06]	94.0 [3.70]	193.8 [7.63]	6.0 [0.24]	5.5 [0.22]
D2	109.0 [4.29]	207.0 [8.15]	187.0 [7.36]	94.0 [3.70]	193.8 [7.63]	6.0 [0.24]	5.5 [0.22]

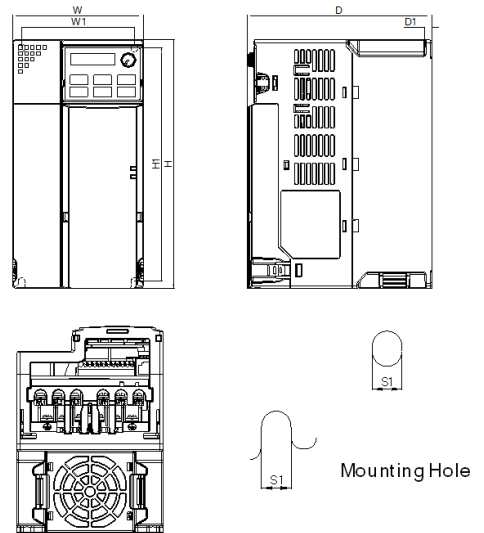

Frame sizes and dimensions in mm [inches] (cont'd)

Frame E

Frame	Unit : mm [inch]						
	W	H	D	W1	H1	D1	S1
E1	130.0 [5.12]	250.0 [9.84]	185.0 [7.33]	115.0 [4.53]	236.8 [9.32]	6.0 [0.24]	5.5 [0.22]
E2	130.0 [5.12]	250.0 [9.84]	219.0 [8.62]	115.0 [4.53]	236.8 [9.32]	6.0 [0.24]	5.5 [0.22]

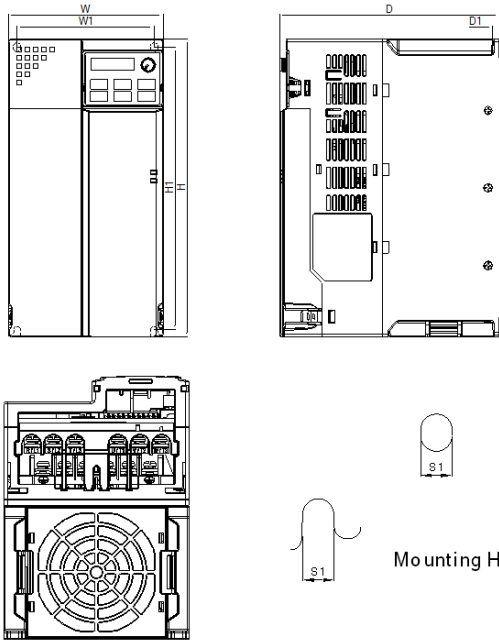

Frame F

Frame	Unit : mm [inch]						
	W	H	D	W1	H1	D1	S1
F1	175.0 [6.89]	300.0 [11.81]	192.0 [7.56]	154.0 [6.06]	279.5 [11.00]	6.5 [0.26]	8.4 [0.33]
F2	175.0 [6.89]	300.0 [11.81]	244.0 [9.61]	154.0 [6.06]	279.5 [11.00]	6.5 [0.26]	8.4 [0.33]

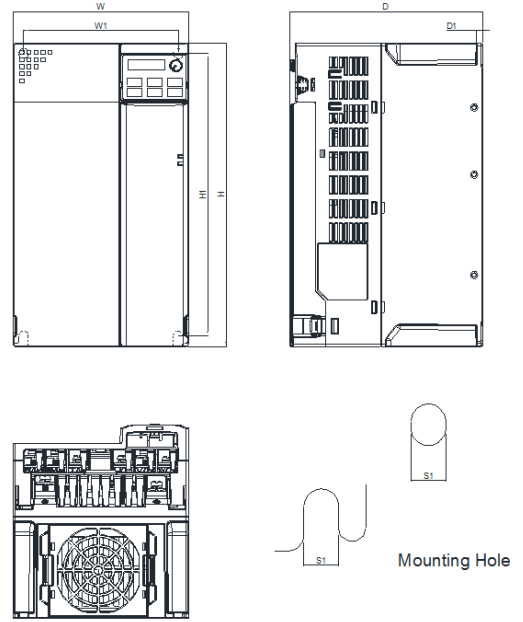

Main circuit wiring

Main circuit wiring Frame B

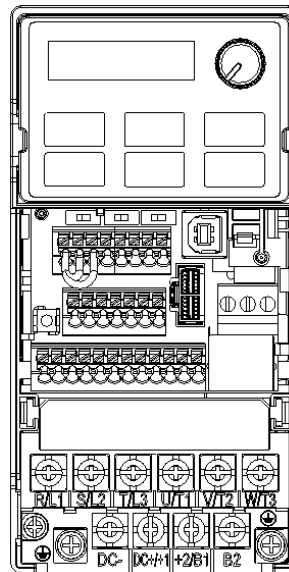

Main circuit wiring (cont'd)

Main circuit wiring Frame C

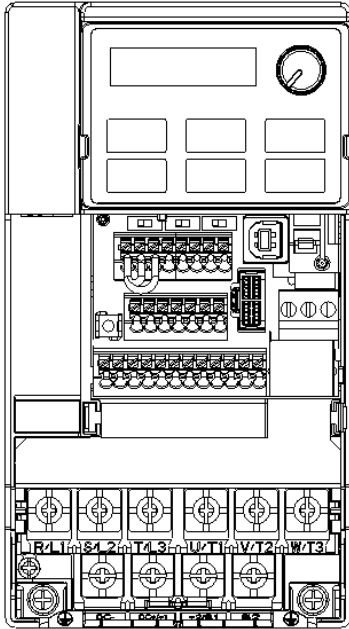

Main circuit wiring Frame D

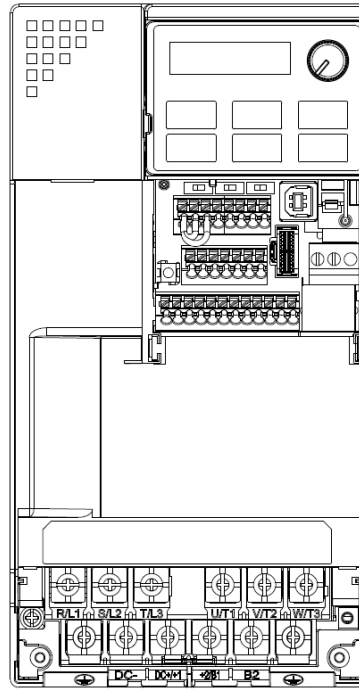

Main circuit wiring Frame E

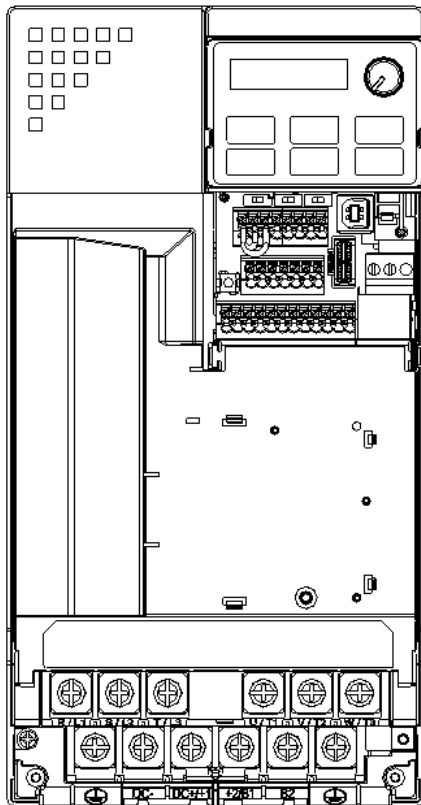

Main circuit wiring Frame F

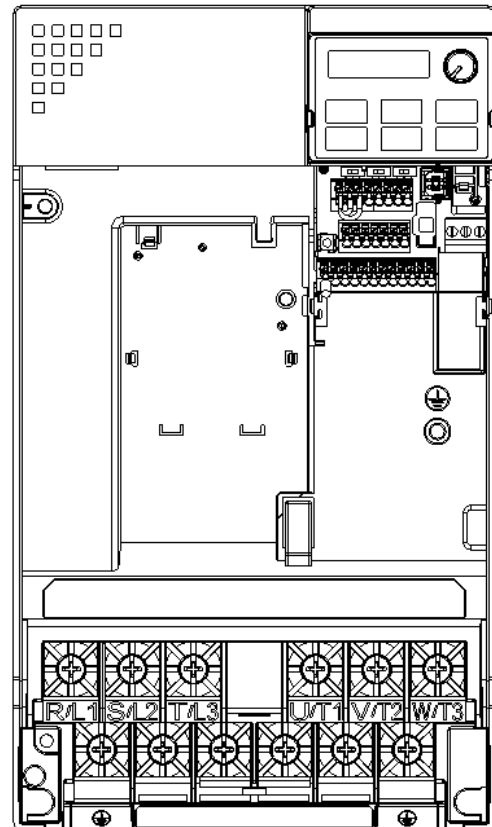

Common data MS300

Mains voltage range	VAC	230VAC: 170 ~ 265 400VAC: 323 ~ 528
Mains frequency	Hz	47 ~ 63
Output frequency range	Hz	0 ~ 1500
Output voltage range	V	0 ~ Mains
Operating		
Temperature	°C	IP20: -20 ~ +50 (+60 with derating)
Atmospheric pressure	kPa	IP40/zero stacking: -20 ~ +40 (+50 with derating)
Relative humidity	%	86 ~ 106
Installation location		≤90 (non condensing, non frozen)
Pollution level		IEC60364-1/60664-1: Pollution degree 2, Indoor use only IEC721-3-3: 3C2, 3S2
Storage		
Temperature	°C	-40 ~ +85
Atmospheric pressure	kPa	70 ~ 106
Relative humidity	%	≤95 (non condensing, non frozen)
Pollution level		IEC721-3-3: 2C2, 2S2
Transportation		
Temperature	°C	-20 ~ +70
Atmospheric pressure	kPa	70 ~ 106
Relative humidity	%	≤95 (non condensing, non frozen)
Pollution level		IEC721-3-3: 1C2, 1S2
Vibration		
Operating		IEC60068-2-6: 2~13.2Hz 1mm 13.2~55Hz 0.7~2.0G 55-512Hz 2G
Non operating		IEC60068-2-6: 2~2000Hz 0.381mm max 2.5G peak
Shock		IEC60068-2-27: 15G 11ms operating 30G 11ms non-operating
Package drop		IEC60068-2-31 ISTA 1A (acc. to weight)
Degree of protection		IP20 IP40 with option conduit box
Altitude	m	≤1000 derate 1% rated current or 0.5°C per 100m up to 2000m
Keypad		Detachable
Signal cable section	mm ²	0.5 (Relay 0.2~3.3)
Digital inputs	7x Mix	SINK or SOURCE Via switch Range 24VDC Scan time 0~30s Pull-up (internal) ca. 4kΩ Current (ON) 3.3mA
STO inputs	S1-DCM S2-DCM	Range 24VDC (30VDCmax) Current (ON) 6.67mA (11VDC switching)
Analogue inputs		Resolution 12 bits Delay 0~20s
	1x AVI	Range 0~10VDC / -10 ~ +10VDC Impedance 20kΩ
	1x ACI	Range 0/4~20mA / 0~10VDC Impedance 250Ω / 20kΩ
Digital outputs	2x MOx	Optocoupler OC (common + or -) 48VDC/50mA
Frequency output	1x DFM	Optocoupler OC 30VDC/30mA Duty-cycle 50% Range 1~55x Output frequency (33kHz max)
Analogue output	AFM	Resolution 10 bits Range 0~10VDC / 0/4~20mA (switch) Max load 2mA / 500Ω

Relays	1x	Change-over	
		NO: R _A ~R _C	Resistive 3A/250VAC - 5A/30VDC Inductive 1.2A/250VAC - 2A/30VDC
		NC: R _B ~R _C	Resistive 3A/250VAC - 3A/30VDC Inductive 1.2A/250VAC - 1.2A/30VDC
Signal supply	1x	+24VDC±10%/100mA	
Potentiometer supply	1x	+10.5±0.5VDC/20mA	
Trip memory		Last 6 errors	
Acc/Dec Times	s	0.0 ~ 6000	
Serial communication	RJ45 SG+/SG-	Modbus RS485 COM1	
		Baudrate	4800 ~ 115200bps
		Address	1 ~ 254
		Mode	ASCII 7,N,2 / 7,E,1 / 7,O,1 / 7,E,2 / 7,O,2 / 8,N,1 / 8,N,2 / 8,E,1 / 8,O,1 / 8,E,2 / 8,O,2
			Modbus RTU 8,N,1 / 8,N,2 / 8,E,1 / 8,O,1 / 8,E,2 / 8,O,2
	USB	Automatic	

NPN/PNP wiring for MIx

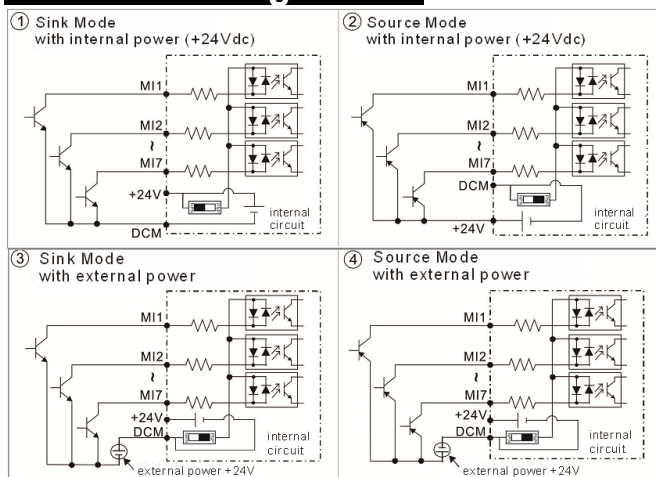

Power terminals (general)

Terminal symbol	Terminal function
R/L1, S/L2, T/L3	Mains input
U/T1, V/T2, W/T3	Motor output
+1/DC+ ~ +2/B1	Connection DC-choke (external option)
+2/B1 ~ B2	Brake resistor (external option)
+1/DC+ ~ DC-	DC-bus connection
	Ground

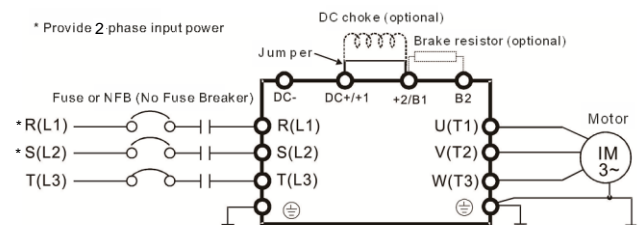

Basic wiring diagram

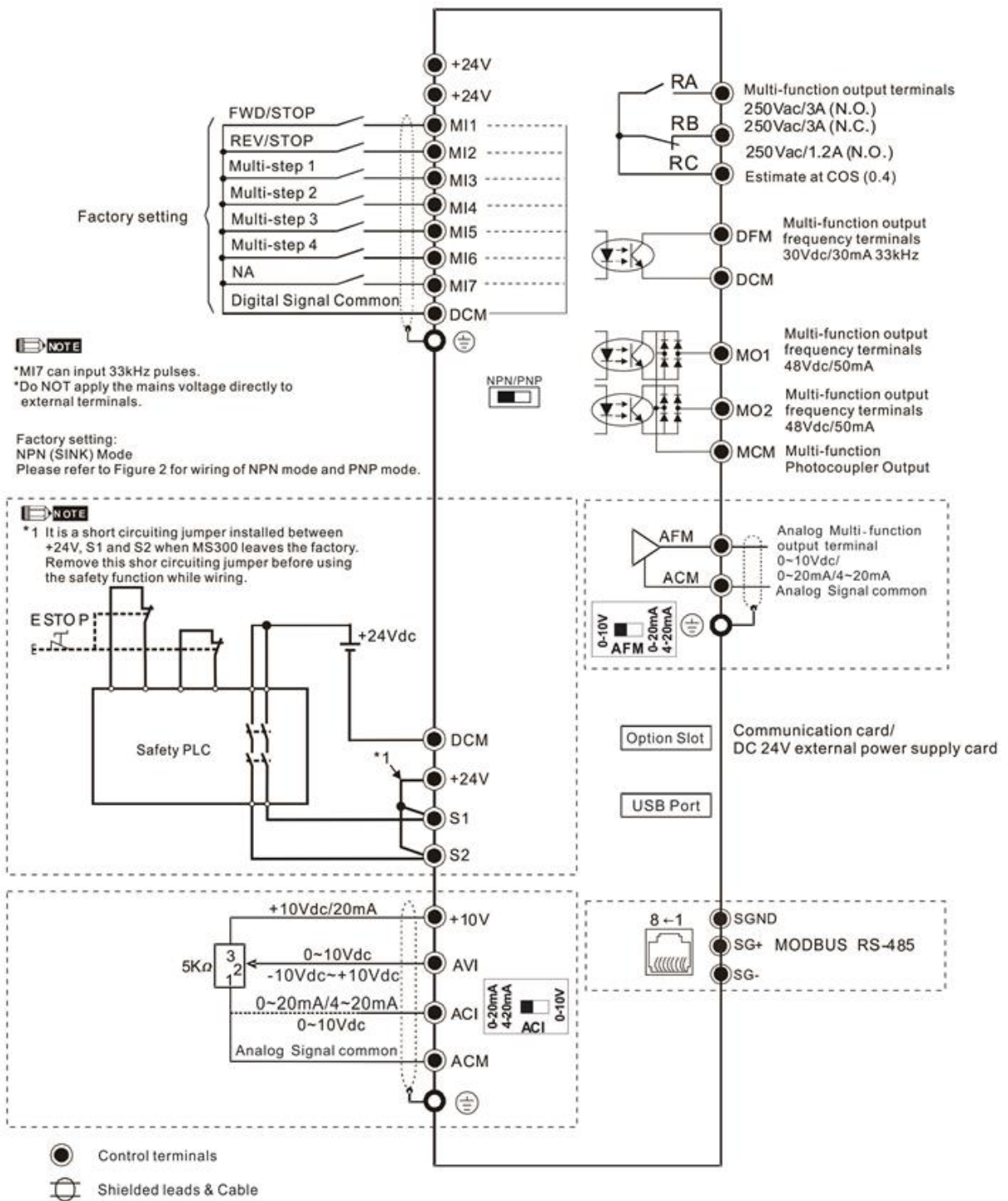

Options

Filters

Built-in filter: C3, motor cable $\leq 30\text{m}$, carrier frequency 2~15kHz
C2, motor cable $\leq 20\text{m}$, carrier frequency 2~15kHz

Option EMC filters
Capacitive filter

Braking

Brake resistors.

Keypad&Cables

The standard keypad KPMS-LE01 can be connected to the drive via EGx010C cable.
The option keypad KPC-CC01 can be connected to the RS485 port.

Reactors

AC input reactors
AC output reactors
DC-chokes
Zero-phase reactors

Mechanical options

Earth plates
Conduit boxes
Fan kits
DIN-rail adapters (up to Frame C)
Mounting adapters (feed-through installation)

Communication

IFD6500/IFD6530 USB-RS485 converter, Splitters, Cables.

Fieldbus

CMM-DN01	Devicenet
CMM-PD01	Profibus
CMM-COP01	CANopen
CMM-MOD01	Modbus over TCP/IP
CMM-EIP01	Ethernet

Option cards

EMM-BPS01 To connect external 24VDC supply

Software

To read, save, copy, change parameters. Download VFDSOft 1.50 or higher from www.delta-emea.com.

Programming

Group 00-xx

Drive Parameters

Drive ID, Software version, Password, Parameter reset, Control Mode, Duty selection, User-defined display, Carrier frequency, Source of frequency/operation, Stop method, Motor direction inhibit, HD selection, etc.

Group 01-xx

Basic Parameters

V/f-curve (2), Max/Min Voltage and frequency, Acc/Dec times, Jogging, S-curve, 3 Skip frequencies, etc.

Group 02-xx

Digital Input/Output Parameters

2-3 Wire operation, Function and setting of digital inputs, outputs and relay, Count values, Debounce time, Brake delay, etc.

Group 03-xx

Analogue Input/Output Parameters

Function, Gain, Bias, Filtering of analogue inputs and outputs.

Group 04-xx

Multi-step Speed and Position

15 Speed steps and positions.

Group 05-xx

Motor Parameters

Setting of motor parameters (2 motors), Auto-tuning, Slip compensation, Torque boost, Y- Δ switch-over, Motor operation time, etc.

Group 06-xx

Protection Parameters

Protection settings, Fault memory and conditions, PTC, etc.

Group 07-xx

Special Parameters

Brake level, DC-Braking, Power loss override, DEB, Speed search, Auto reset, Fan control, Emergency stop, Auto Energy Saving, AVR, Slip compensation, Autorestart, etc.

Group 08-xx

PID Control Parameters

PID settings, Sleep function, etc.

Group 09-xx

Communication Parameters

Protocol, Address, Transmission speed, Block Transfer, CANopen, Fieldbus settings, etc.

Group 11-xx

Advanced Parameters

Several advanced bit settings

Group 13-xx

Macro

Application Macro settings

PLC-mode

PLC functionality via Editor on PC: Disable, Run, Edit, Read/Write in MS300

>100 Commands
10 Input and 4 Output contacts
32 points
2000 steps

www.delta-emea.com

